



Small commercial downlights



Description

With anti glare technology this tiny recessed light will be welcome in any interior. A range of ring and diffuser colours will also mean this works with your interior scheme.

Features

- Aluminium housing
- Compact light 55mm inc ring.
- Anti glare design
- 3000K or 4000K Ra>82
- Beam angle 15/20/30 degrees
- Cutout 50mm
- Dimming –DALI/1-10v/Switching
- 3w 206 lumens
- 5w 271lumnes
- 10w 796 lumens

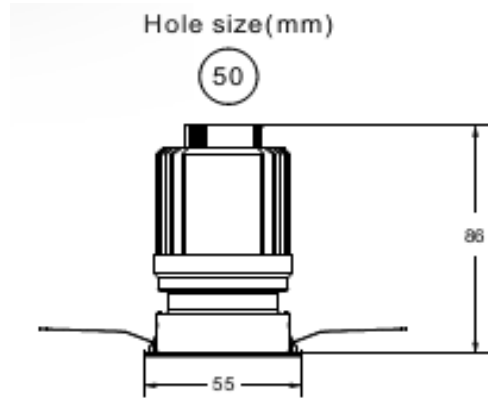

Reflector options

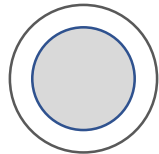

WS-White Silver

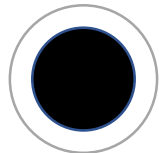

WB-White Black

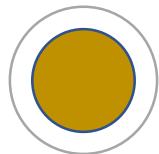

WG- White Gold



Description

Adjustable recessed spot light with anti glare technology this tiny recessed light will be welcome in any interior. A range of ring and diffuser colours will also mean this works with your interior scheme.

Features

- Aluminium housing
- Compact light 55mm inc ring.
- Anti glare design
- 3000K or 4000K Ra>82
- Beam angle 15/20/30 degrees
- Cutout 50mm
- Adjustable 0-20 degree tilt
- Dimming –DALI/1-10v/Switching
- 3w 206 lumens
- 5w 271lumnes
- 10w 796 lumens

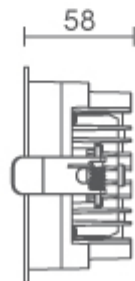
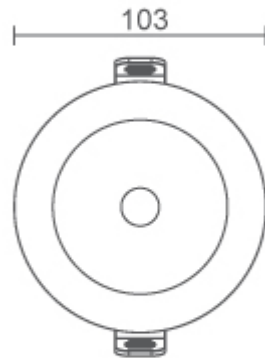

Description

BURST-M has a choice of beam angles and outputs make this a very versatile downlight.. The BURST is low in height making it suitable for most applications

Features

- Aluminium housing
- Compact light 103mm inc ring.
- Anti glare design
- 3000K or 4000K Ra>82
- Beam angle 36/60 degrees
- Cutout 90mm
- Dimming –DALI/1-10v/Switching
- 8w 776 lumens
- 11w 958 lumens

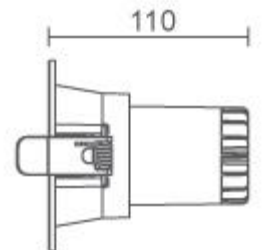

Description

The CRICKET uses the CREE XPE LED engine to ensure quality and longevity of the downlight. A choice of beam angles and outputs make this a very versatile downlight.

Features

- Aluminium housing
- Compact light 90mm inc ring.
- IP65 rated
- 3000K or 4000K Ra>82
- Beam angle 14/24/36 degrees
- Cutout 80mm
- Dimming –DALI/1-10v/Switching
- 8w 630 lumens
- 10w 800 lumens

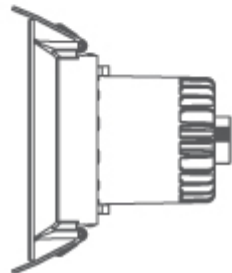
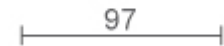

Description

Higher output in a compact form factor the MANTIS also has a choice of beam angles and outputs make this a very versatile downlight..

Features

- Aluminium housing
- Compact light 105mm inc ring.
- Anti glare design
- 3000K or 4000K Ra>82
- Beam angle 24/36/60 degrees
- Cutout 90mm
- Dimming –DALI/1-10v/Switching
- 13w 1180 lumens
- 15w 1430 lumens
- 20w 1860 lumens

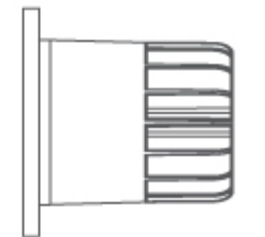
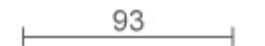

Description

The RAY uses the CREE XPE LED engine to ensure quality and longevity of the downlight. A choice of beam angles and outputs make this a very versatile downlight.
IP65 rated

Features

- Aluminium housing
- Compact light 90mm inc ring.
- IP65 rated
- 3000K or 4000K Ra>82
- Beam angle 38/60 degrees
- Cutout 70mm
- Dimming –DALI/1-10v/Switching
- 9w 840 lumens
- 12w 1050 lumens



VIPE-O



VIPE-P

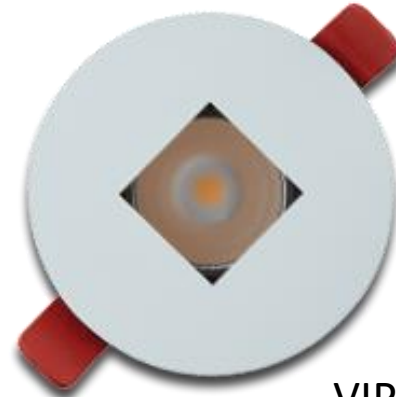

VIPE-S

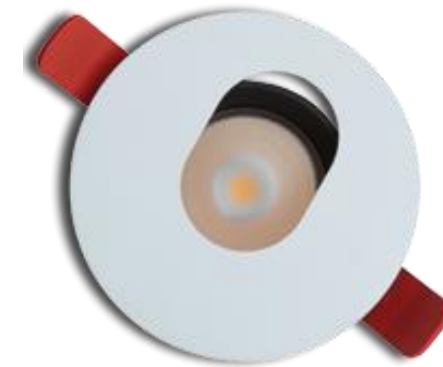

VIPE-E

Description

The Vipe range uses the CREE XPE LED engine to ensure quality and longevity of the downlight.

The Vipe uses a die-cast aluminium heatsink which houses the LED module. The bezel of the downlight is machined from aluminium ensuring a constant high quality finish with no surface blemishes.

The Vipe is available in 640, 800, 960 & 1,200 lumen outputs

Features

- Aluminium housing
- Compact light 90mm inc ring.
- 3000K or 4000K Ra>82
- Beam angle 15/24/36 degrees
- Cutout 75mm
- Dimming –DALI/1-10v/Switching
- 8w 638 lumens
- 11w 796 lumens
- 13w 957 lumens
- 15w 1199 lumens

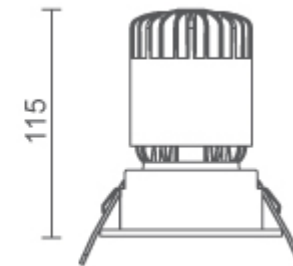
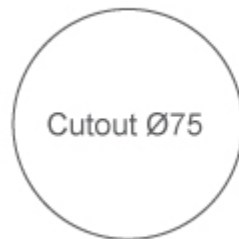

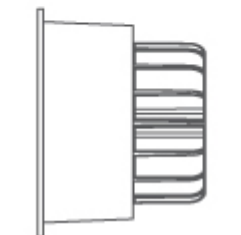
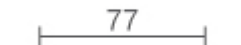

Description

Good output in a compact glare free design. The WOLF also has a choice of beam angles. A high efficiency reflector produces a very effective spot light

Features

- Aluminium housing
- Compact light 90mm inc ring.
- Anti glare design
- 3000K or 4000K Ra>82
- Beam angle 24/ 36/ 60 degrees
- Cutout 83mm
- Dimming –DALI/1-10v/Switching
- 10w 912 lumens





Medium commercial downlights

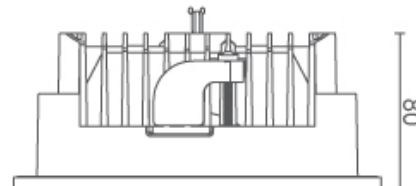
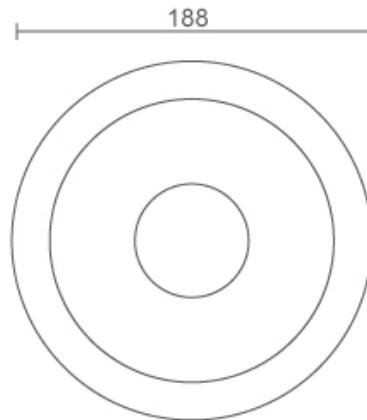

Description

A standard sized commercial downlight packing a UGR<19 rating and high efficiency of >100 lm/cw. IP44/65 versions also available

Features

- Aluminium housing
- Anti glare design UGR<19
- 3000K or 4000K Ra>82
- Beam angle 90 degrees
- Cutout 160mm
- Dimming –DALI/1-10v/Switching
- 15w 1650 lumens
- 20w 2200 lumens
- IP44 option
- IP65 option

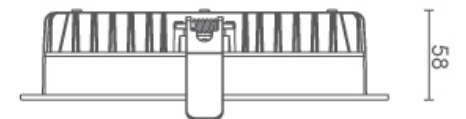
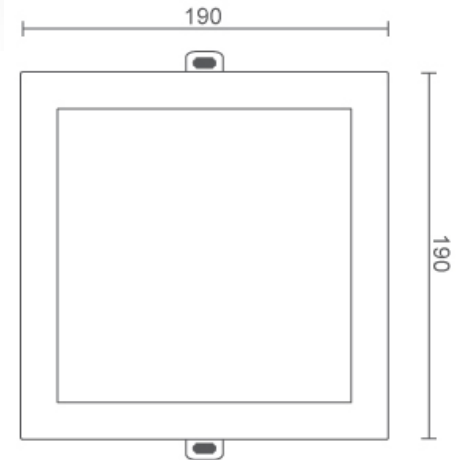

Description

The VULCAN is a economical downlight with good efficiency and light output. Very low void to fit into tight spaces. The VULCAN has a recessed mounted frosted opal optic

Features

- Aluminium housing
- 3000K or 4000K Ra>80
- Beam angle 90 degrees
- Cutout 165x 165mm
- Dimming –DALI/1-10v/Switching
- 15w 1271 lumens
- 22w 1805 lumens
- 35w 2697 lumens

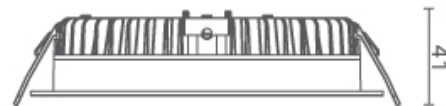
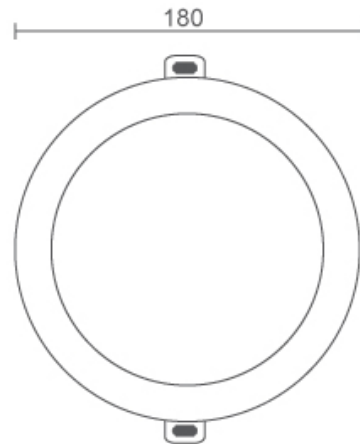

Description

The STALK-R is a economical downlight with good efficiency and light output. Very low void to fit into tight spaces. The STALK has a recessed mounted frosted opal optic

Features

- Aluminium housing
- 3000K or 4000K Ra>80
- Beam angle 90 degrees
- Cutout 160mm
- Dimming –DALI/1-10v/Switching
- 15w 1290 lumens
- 22w 1840 lumens

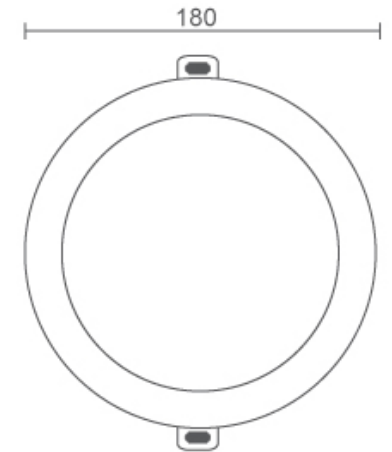

Description

The STALK is a economical downlight with good efficiency and light output. Very low void to fit into tight spaces. The STALK has a flush mounted frosted opal optic

Features

- Aluminium housing
- 3000K or 4000K Ra>80
- Beam angle 90 degrees
- Cutout 160mm
- Dimming –DALI/1-10v/Switching
- 15w 1290 lumens
- 22w 1840 lumens

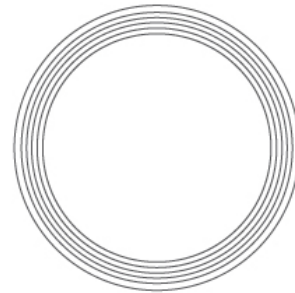
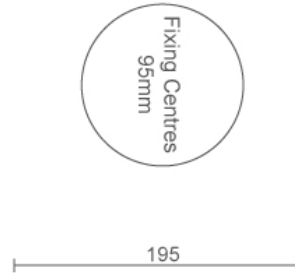

130

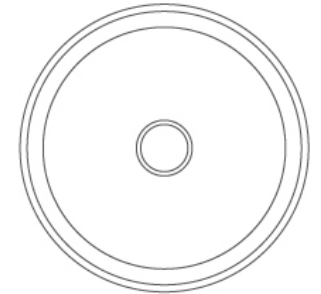
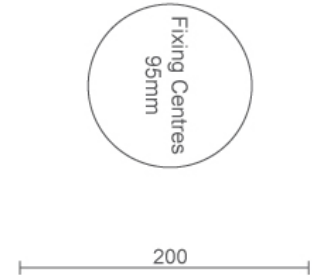

139

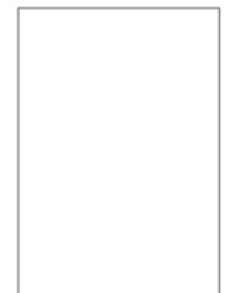

Description

The Brevis D (Diffuser) is a Ø195mm large area downlight which can be surface (Standard) or suspended mounted. The heatsink is built into the body of the product which enables the downlight to run at cool temperatures without the common need for vents in the vertical walls. The downlight also has an IP44 rating when surface mounted.

Features

- Aluminium housing
- 3000K or 4000K Ra>80
- 130mm high
- Beam angle 60 or 90 degrees
- White black or grey finishes
- Dimming –DALI/1-10v/Switching
- 15w 1360 lumens
- 20w 1800 lumens

Description

The Brevis R (Recessed Light Source) is a Ø200mm large area downlight which can be surface (Standard) or suspended mounted. The heatsink is built into the body of the product which enables the downlight to run at cool temperatures without the common need for vents in the vertical walls. The downlight also has an IP44 rating when surface mounted.

Features

- Aluminium housing
- IP44 rated (surface mounted)
- 3000K or 4000K Ra>80
- 139mm high
- Beam angle 60 degrees
- White black or grey finishes
- Dimming –DALI/1-10v/Switching
- 15w 1450 lumens
- 21w 1990 lumens

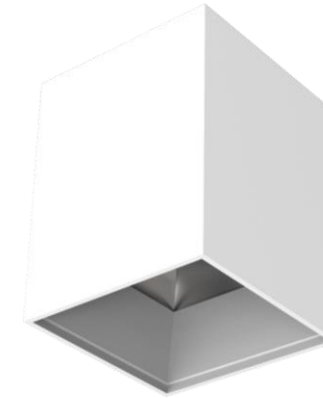
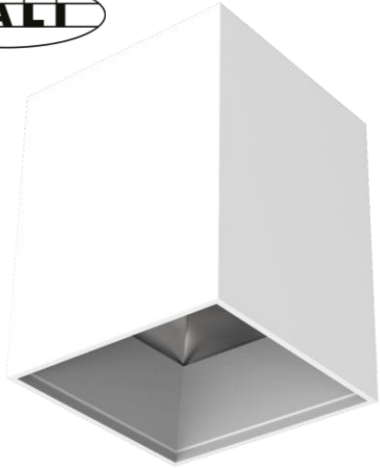

Description

The Brevis R (Recessed Light Source) is 121mm square medium area downlight which can be surface (Standard) or suspended mounted. The heatsink is built into the body of the product which enables the downlight to run at cool temperatures without the common need for vents in the vertical walls. The downlight also has an IP20 rating when surface mounted.

Features

- Aluminium housing
- 3000K or 4000K Ra>80
- 133mm high
- Beam angle 38 degrees
- White black or grey finishes
- Dimming –DALI/1-10v/Switching
- 15w 1450 lumens
- 20w 1990 lumens

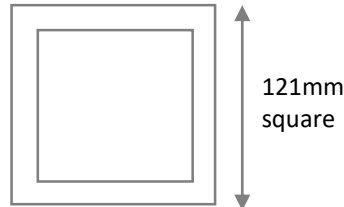
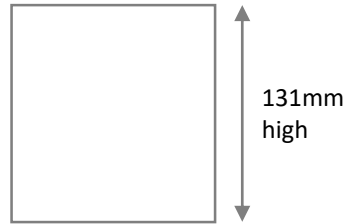

Description

The Brevis R (Recessed Light Source) is a 81mm square small area downlight which can be surface (Standard) or suspended mounted. The heatsink is built into the body of the product which enables the downlight to run at cool temperatures without the common need for vents in the vertical walls. The downlight also has an IP20 rating when surface mounted.

Features

- Aluminium housing
- 3000K or 4000K Ra>80
- 104mm high
- Beam angle 60 degrees
- White black or grey finishes
- Dimming –DALI/1-10v/Switching
- 10w 948 lumens
- 15w 1450 lumens

